











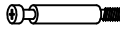

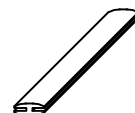

<b>A</b>	x12	<b>B</b>	x12	<b>C</b>	x12	<b>D</b>	x12	<b>F</b>	x40
									
<b>G</b>	x2	<b>K</b>		<b>J</b>	x12	<b>L</b>	x2	<b>Q</b>	x4
				$\varnothing 5 / \varnothing 13\text{mm}$ 				$3,5 \times 16\text{mm}$ 	

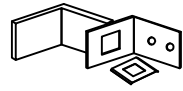
		 $\varnothing 5,5$		 30 min	
---	---	--	--	---	---

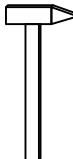
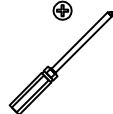
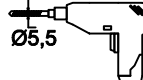

**1.**

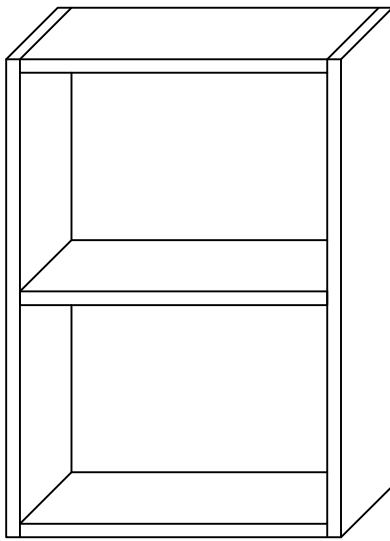
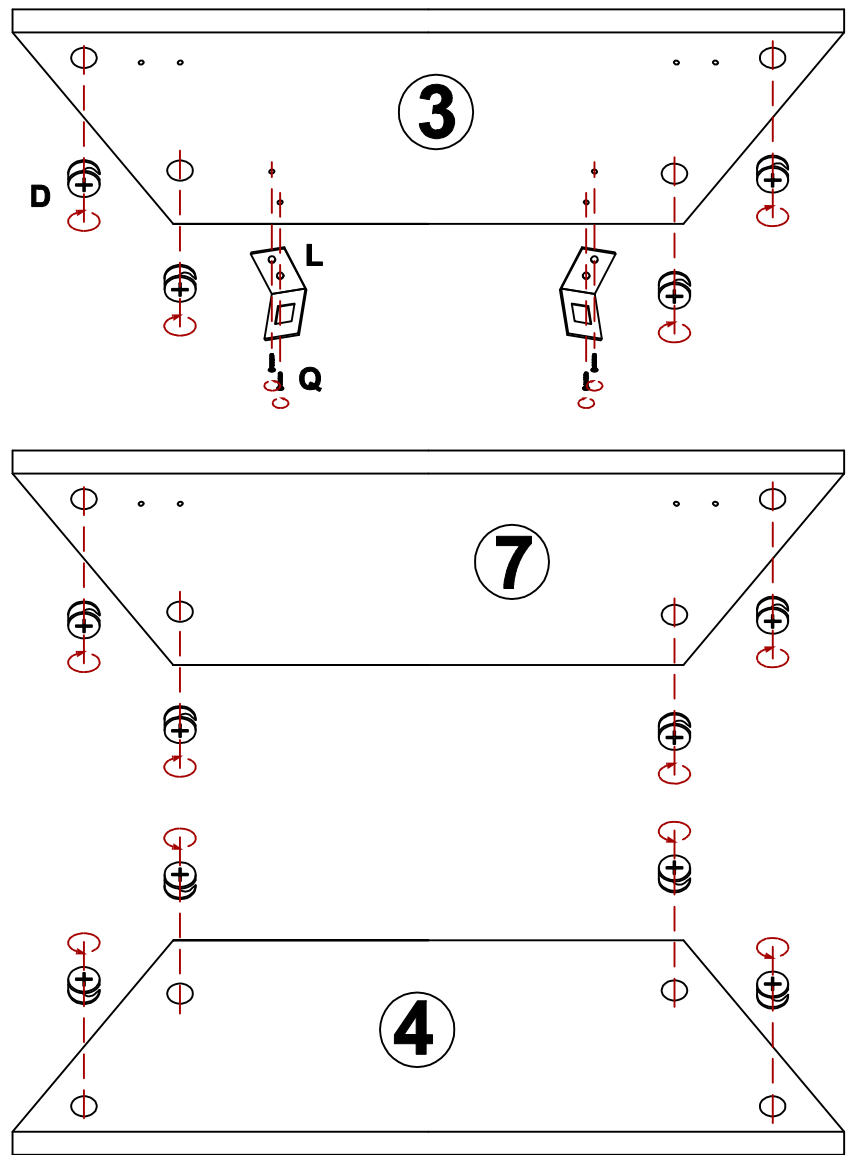

2.

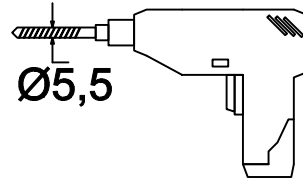
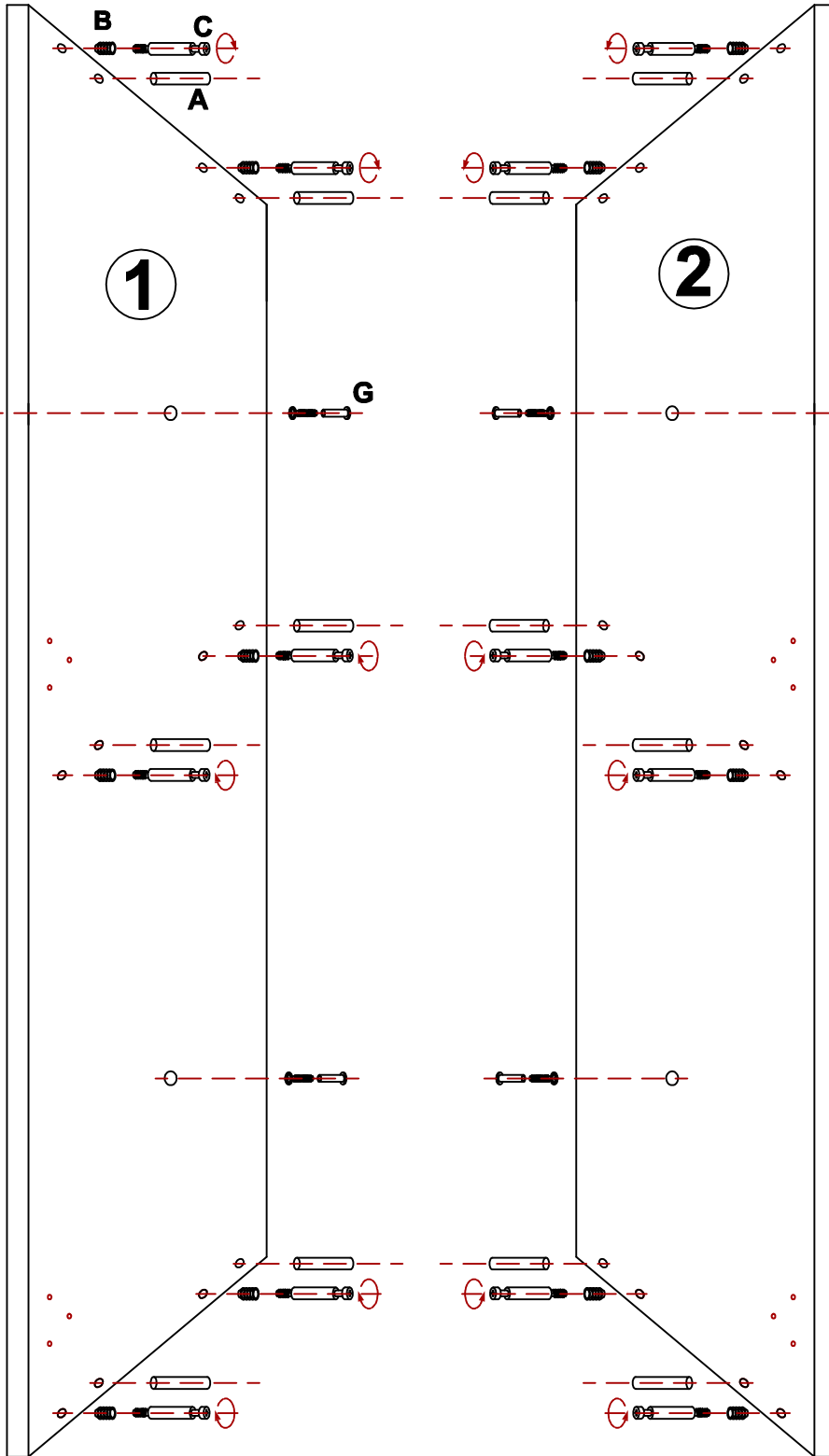
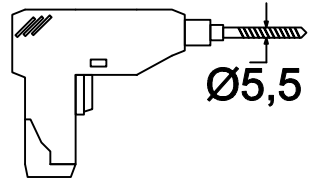

3.

K20 HS2V600 V:720

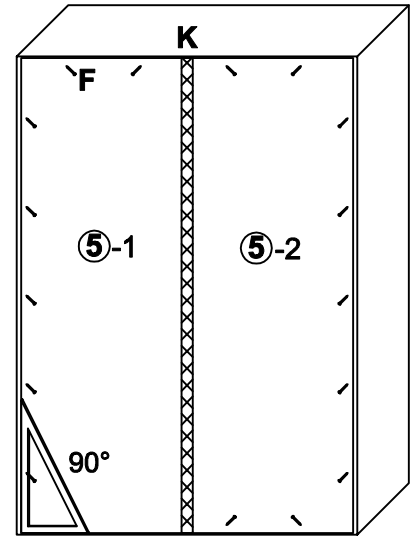
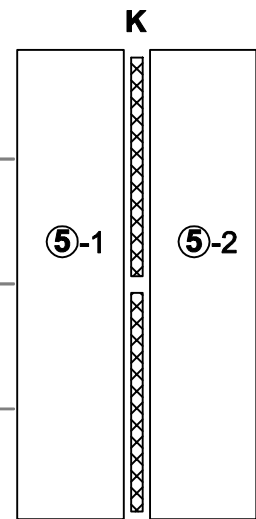
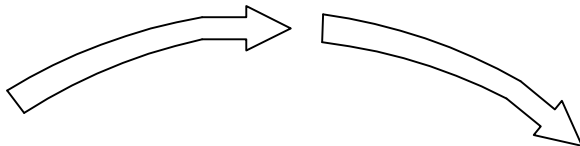
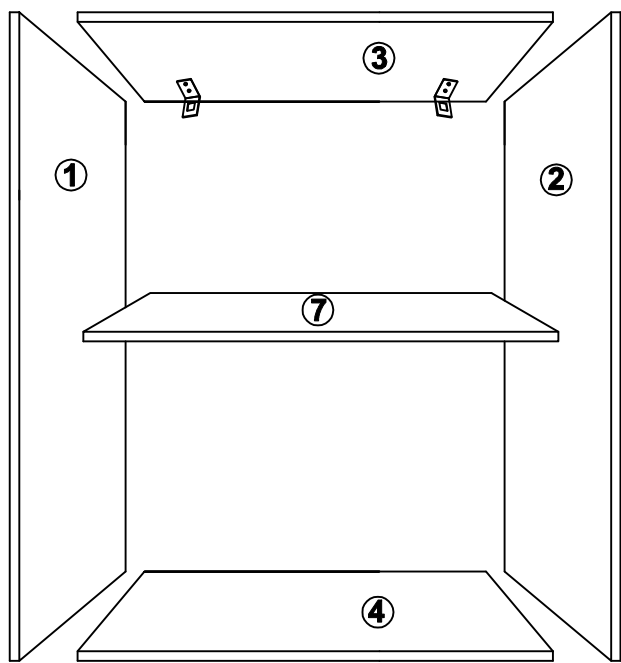

3.

K26 HS2V900 V:720

